

· GH ·

CRANES & COMPONENTS

CONTENTS

4-16

BEINGH	4
Origins	6
Evolution	8
Present day	10
Cranes for life	12
Size of the GH group	14
Production centres and regional branches around the world	16

18-46

EMPOWERINGH	18
Own capabilities	20
Products	22
GH Global Service	42
Sectors	46

60-66

APPROACHINGH	60
Global presence	62
Customer portal	66

70-74

THINKINGH	70
Professional Team	72
GH 4.0	74

76-82

FELLOW TRAVELLERS	76
Customers	78
Olea Prize and Start-up Contest	82

YESTERDAY, WE THOUGHT
ABOUT HOW TO MAKE **BETTER
LIFTING PRODUCTS.**

TODAY, WE DEVELOP **CRANES
THAT THINK.**

WE HAVE GONE FROM
PRODUCING MACHINES TO
CREATING **SMART CRANES**

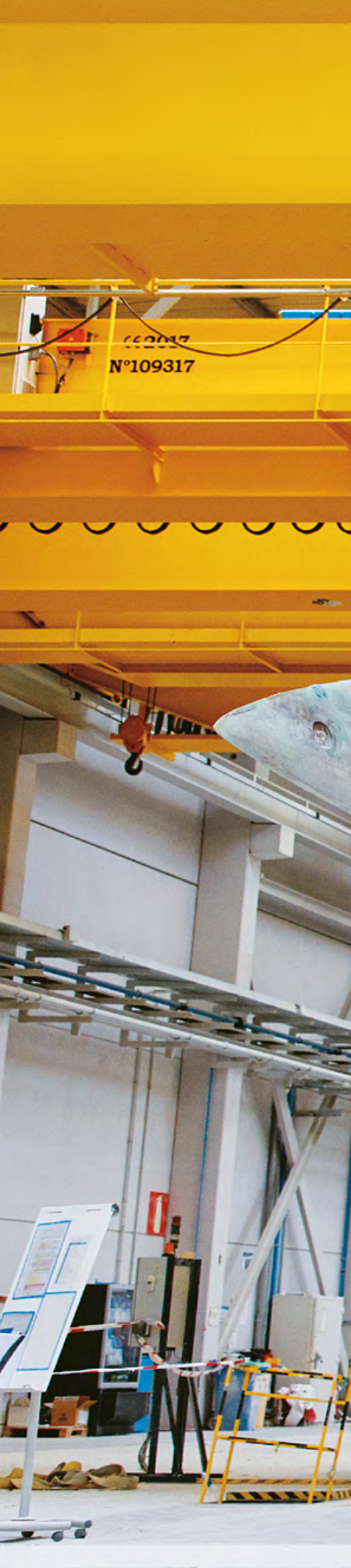

BEING**H**

WE ARE MORE
THAN A CRANE
COMPANY.

WE LIVE AND FEEL
GH.

—

GH
www.ghsa.com

☎ 943 805 660

GH
www.ghsa.com

15/15t 0

GH
CRANES & COMPONENTS

GH
CRANES & COMPONENTS



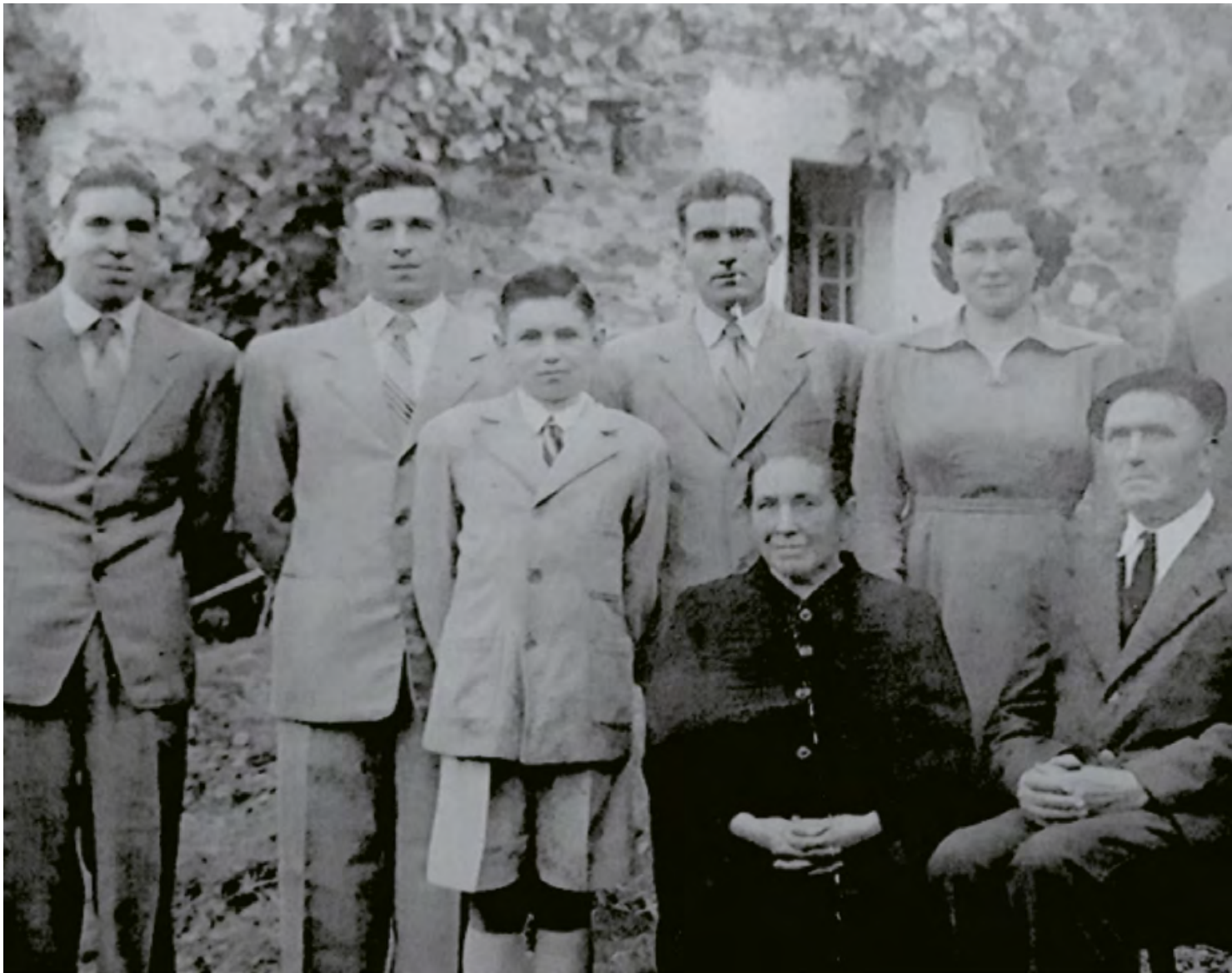

GH UPHOLDS THE PILLARS
OF ITS FOUNDERS:
HONESTY AND GOOD WORK



OUR ORIGINS

In the middle of the last century, driven by the needs of a society that was recovering from its own contradictions, four brothers set up a family business to meet their survival needs and with the healthy ambition to build a project, with people at the centre of everything they did. **65 years and 125,000 cranes later, we are still the same.**

Our company stands firm by the guiding principles of its founders, based on integrity, work well done and the desire to pass on value to our customers.

Now **GH** is a leading company in the field of lifting, with innovative products and customers who are leaders in five continents, and still continuously evolving to adapt to the new demands and technologies that make us more global, accessible and competitive.

OUR OWN HOISTS

65 YEARS

WE ARE LEADERS IN THE MANUFACTURE OF HOISTS THAT MEET THE NEEDS OF THE MOST DEMANDING CUSTOMERS

Our evolution has meant flexibility and continuously adapting to new technologies, with a constant desire for improvement through innovation.

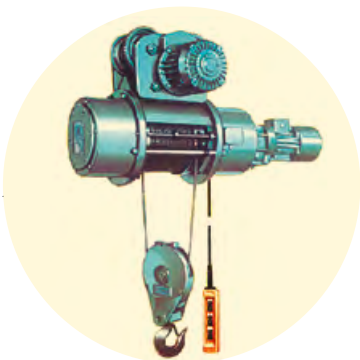

1960

Motor inside the drum with independent gearmotor for reduced speed through clutch.



1980

NF Double Girder hoist with external motor.

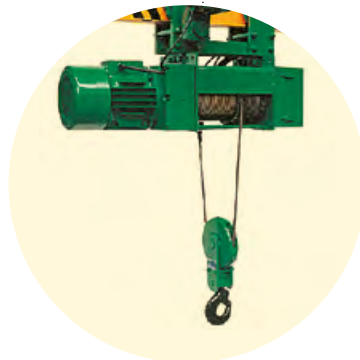

1990

Coaxial hoist with direct drive.



2000

Generation of single girder hoists with low headroom.

**WE BEGAN
65 YEARS AGO AND OUR AMBITION IS
TO CONTINUE FOR ANOTHER 65 YEARS**

WE DEVELOP A REMOTE SERVICE SYSTEM FOR ALL OUR CRANES: COREBOX



COREBOX

3G/4G

2020

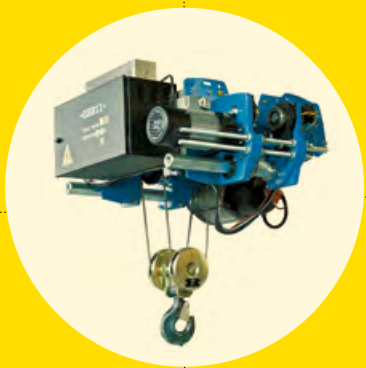

2005

New "C-shaped" design to optimise sizing.

2012

Incorporation of standard drives in the entire range.

MAINTENANCE SERVICE AND CONTINUOUS AND PERSONALISED CONTACT WITH THE CUSTOMER

Warn about incorrect use

Advise about possible failures

Analysis of productivity and efficacy data

Leadership

Workmanship

Innovation

Service

Integrity





COMMITMENT RAISED TO THE POWER OF FIVE

Selecting **GH** is not just picking one of the options. Our experience and our values make us different because leadership for us has always been a question of providing and offering a solution that goes beyond simply delivering a product to a customer. We are proud to grow together with companies that, like ours, **have the desire to define their own boundaries**, with committed people, and with products that are necessary for other companies to achieve their dreams.

Our commitment raised to the power of five is the basis of our day-to-day work.

COMMITMENT RAISED TO THE POWER OF FIVE: Leadership, workmanship, innovation, service and integrity.

COMMITMENT RAISED TO THE POWER OF 5



THE INHERITED SPIRIT OF HARD WORK AND THE WILL TO OVERCOME HAVE LED US TO BECOME A WORLDWIDE CRANE MANUFACTURER

For **six decades**, we have grown in terms of number of workers, regional offices and countries in which we have a presence. We have calculated, formulated and recalculated **millions of loads**, weights, manoeuvres and temperatures. **This is our passion**. But when we look up from our drawings, we see that the work we do helps make everyone's life easier. Because during this time, our machines have been present at works as important as those of the **London Underground**, the oldest in the world, which every day transports more than **3 million** people.

We have also participated in the construction of the **Panama Canal**, through which **5% of world trade passes**. There are **GH** cranes in the most important automotive plants, shipyards and tunnel boring works of the **5 continents**. We work in practically all sectors.

And we believe there is no greater satisfaction than knowing that your work and effort reaches millions of people.

GH. Lifting your world.

■ GH ■
www.gh sa.com

SEATTLE TUNNEL PARTNERS

Tutor Perini
CORPORATION

63 t

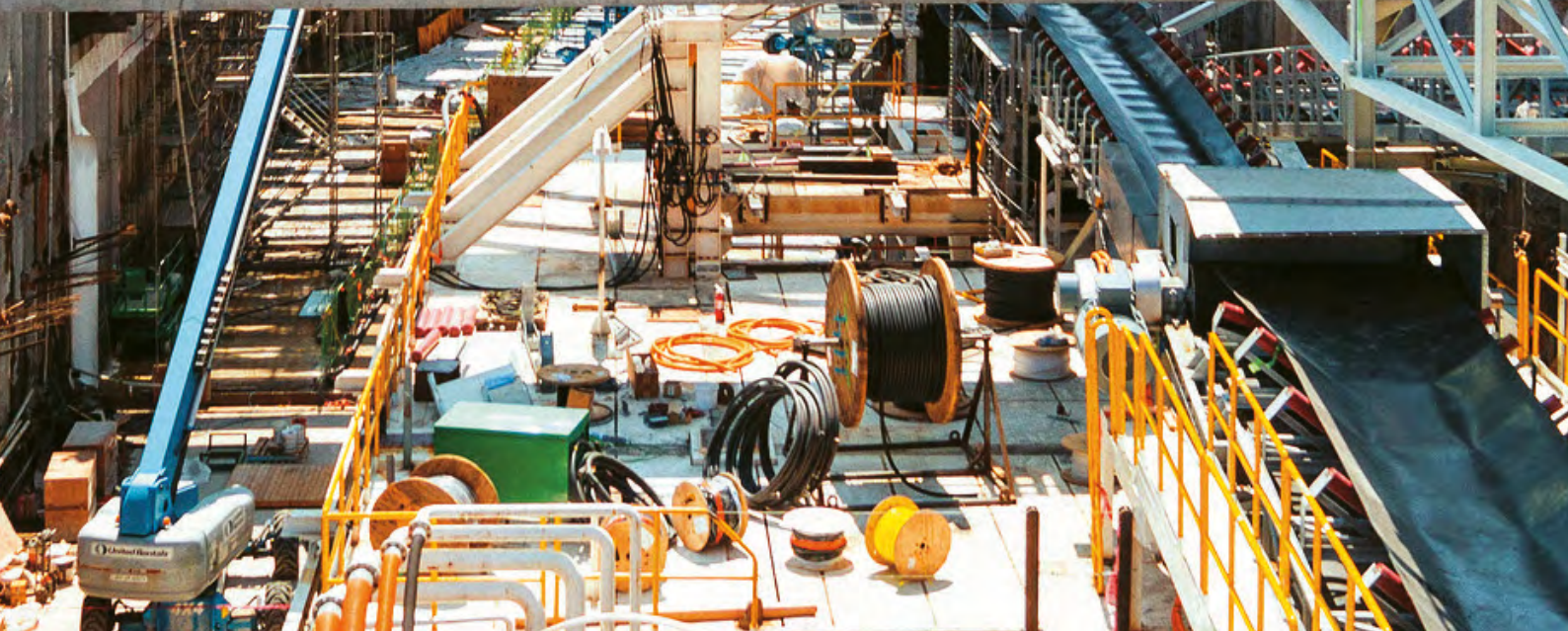

WE ARE A TEAM OF **1004 PEOPLE** AROUND THE WORLD

We are a business group with presence in the five continents. With qualified people from diverse backgrounds. And with a profile that clearly identifies us: comprehensive manufacturers of all our products and components, and with control of all the processes involved in both the manufacture and the service.

125,000+

CRANES SOLD
WORLDWIDE



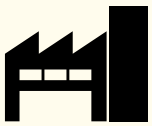
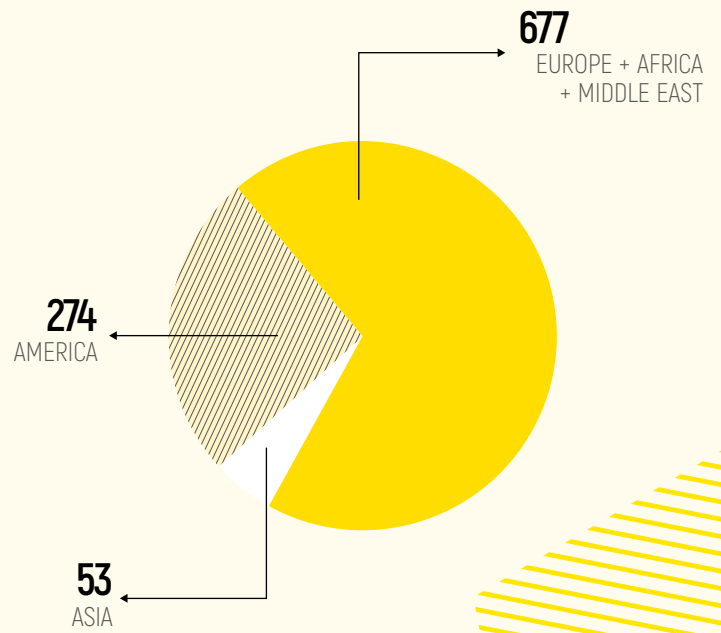
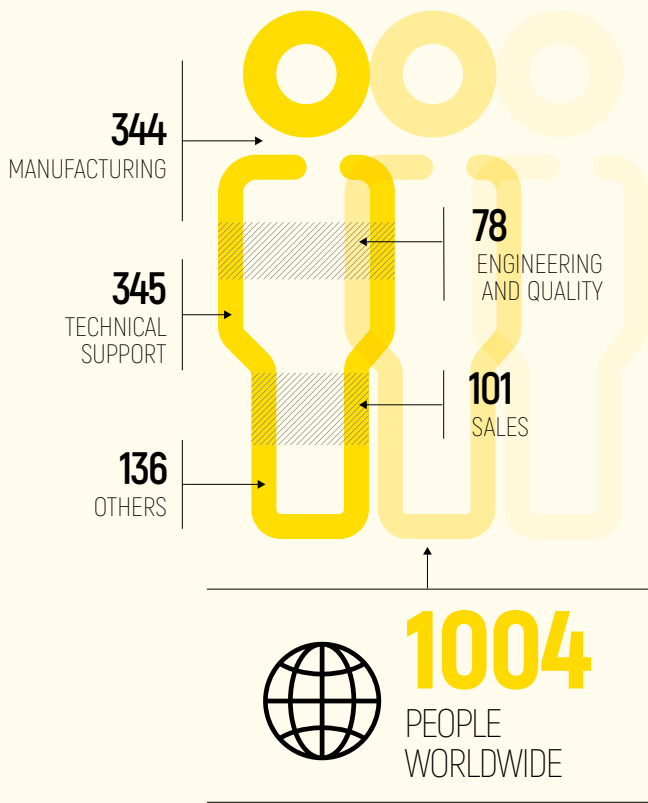

10 MANUFACTURING PLANTS IN THE STRATEGIC MARKETS ESTRATÉGICOS

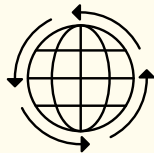

DIRECT PRESENCE WITH OUR OWN COMMERCIAL SUBSIDIARY IN 15 COUNTRIES

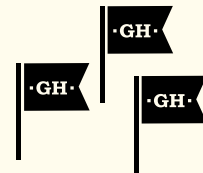

COMMERCIAL PRESENCE IN MORE THAN **70 COUNTRIES** WITH OUR LOCAL COLLABORATORS

IN THE **TOP 5** CATEGORY

OF **CRANE MANUFACTURERS** WORLDWIDE



WE ARE **MARKET LEADERS** IN PORTUGAL AND SPAIN



WE CAN PROVIDE SOLUTIONS IN ANY PART OF THE WORLD

BEINGH _____ PRODUCTION CENTRES AND REGIONAL BRANCHES AROUND THE WORLD



IN EVER MORE LOCATIONS, GETTING CLOSER TO OUR CUSTOMERS



- We have different production and service centres to serve our customers around **the world**.
We also have a commercial presence in **more than 70 countries on 5 continents**.
-



-GH-

CE 2017

-GH-

CE 2010
N°94606

-GH-

-GH-

-GH-

15/15t

EMPOWERING**GH**

WE ARE SELF-SUFFICIENT
MANUFACTURERS.
HOW DO WE DO IT?

BY EXERCISING
CONTROL OVER THE
WHOLE PROCESS.

GH.

—



GH INVESTS IN ITS OWN CAPABILITIES: ENGINEERING, PRODUCTION AND SERVICE

Controlling all the production processes and capacities allows us to have an independent position in the sector as a whole.

The continuous investment in engineering and design, in the production processes, in the after sales and support service, and in the technology applied to all the products, is a constant attitude focused on the market.



THE CONTROL OF OUR PROCESSES ALLOWS US TO PROVIDE COMPREHENSIVE SUPPORT FOR OUR PRODUCTS

Automotive marine gantry crane
Sanxenxo (Spain)



Metrology
Laboratory
Alsasua

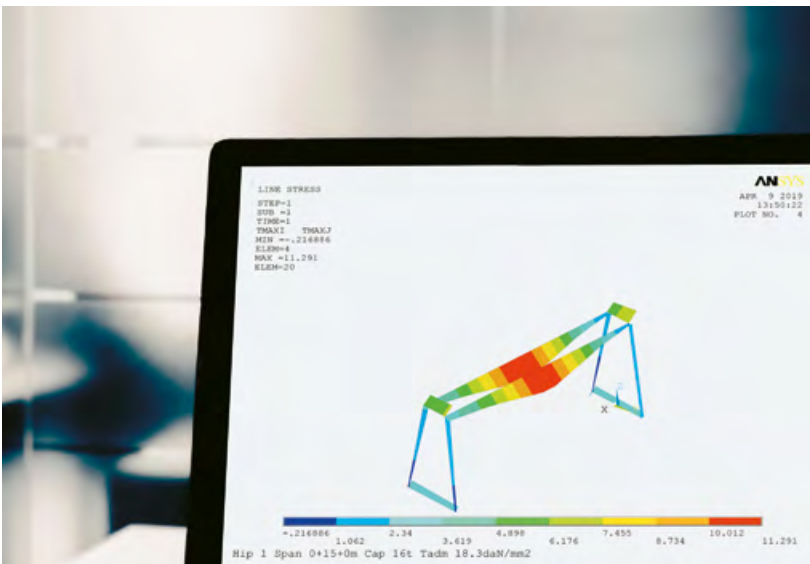

Structural calculation by
finite element analysis

CE 2002

Nº 70836

PRODUCT RANGE INTEGRATION

With our own technology

Safety

Robustness

Reliability

Adaptation to the customer

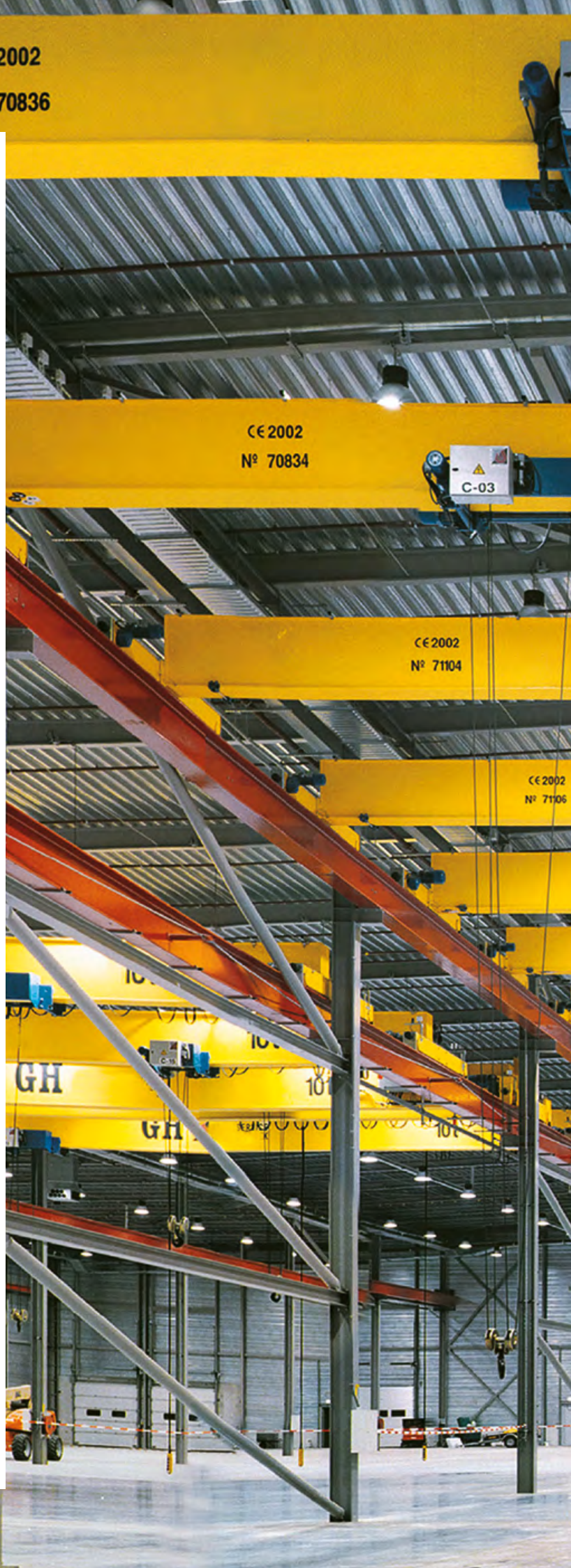
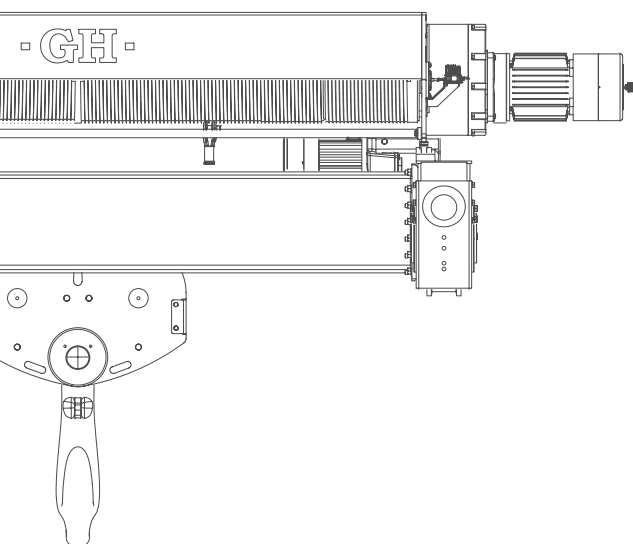

CRANE COMPONENTS

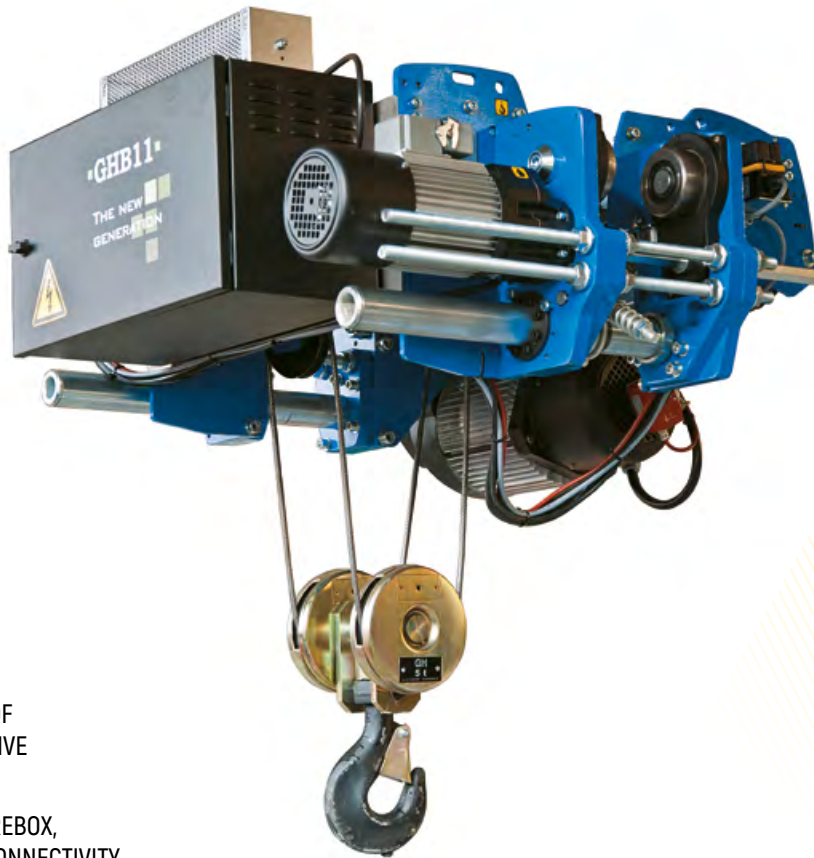

HOISTS

STANDARDISATION OF
VARIABLE SPEED DRIVE

CABINETS WITH COREBOX,
DATALOGGER AND CONNECTIVITY

The **GH** hoists are made using the most modern design technologies. Their manufacture is carried out with the most sophisticated means of production and the appropriate organisation.

GH wire rope hoists for bridge cranes, gantry and semi-gantry cranes, single and double girder, and other types of application. With capacities from 800 kg to 120 t in foot mounted and single and double girder versions. Robust and compact, modular construction and easy maintenance, with different wire rope falls, allows a wide range

of hook paths, lifting speeds and **FEM / ISO** work groups depending on the requirements in terms of starts per hour and duty cycles for the loads to be lifted.

The **GH** hoists incorporate the control system and monitoring of the Safe Operation Period as standard.

The range of **GH** hoists has been designed based on the principles of reliability, safety, durability, competitive price, easy maintenance and, of course, availability.

**WITH CAPACITIES FROM
800 KG TO 120 T**

HOISTS

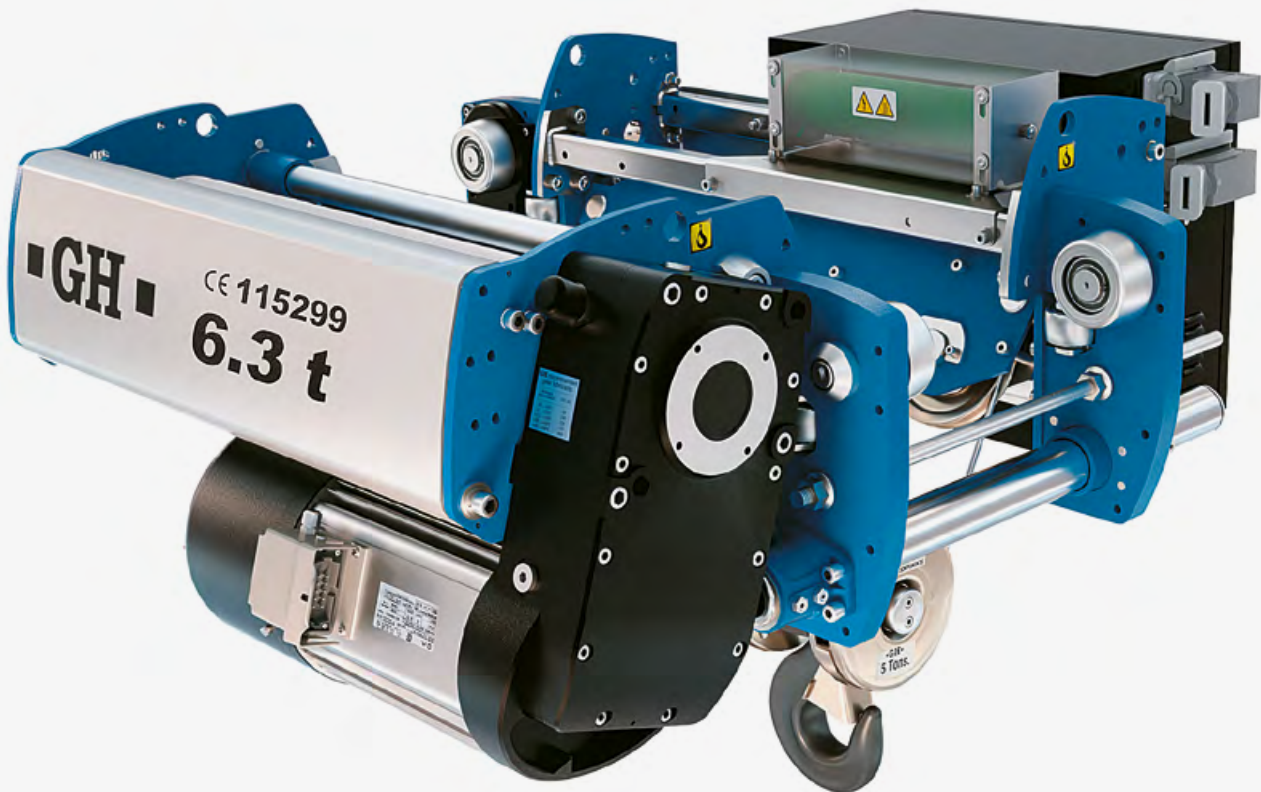

1

CRANE COM- PONENTS



2

From 800 kg up to 120 t



1. **GHA12** HOIST
Low headroom

2. **GHB11** SINGLE
GIRDER HOIST

3. **GHD13** HOIST
Normal headroom/
for curves

4. **GHB11** HOIST
Foot mounted
Execution 1/1

5. **GHD13** HOIST
Tubular double
girder

6. **GHD13** HOIST
Double girder
on end carriages

7. CABINET WITH
REGENERATIVE MODULE
for GHB11 hoist

CRANE KIT

The Crane Kits, with both standardised and special components, allow the easy construction of top running or underslung EOT cranes, as well as Gantries and Semi Gantries.

They allow cranes to be manufactured with just the beams being available. They are supplied with the project design and all the crane components and accessories, including the electrical equipment.

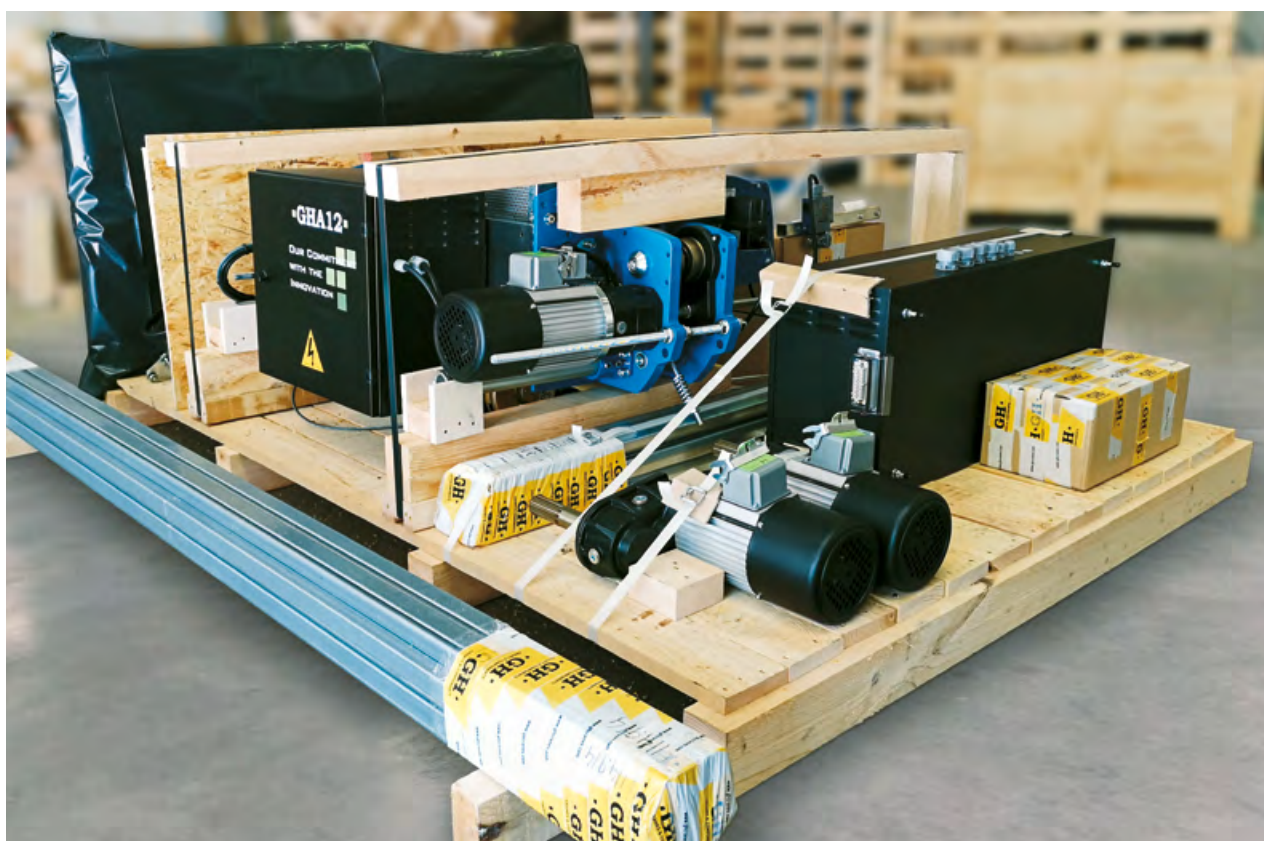
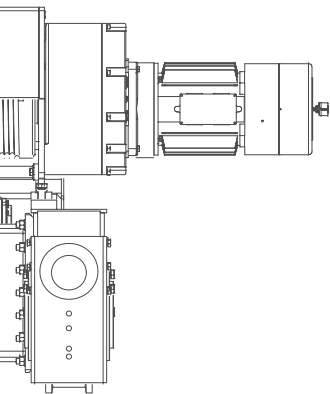

CRANE COM- PONENTS

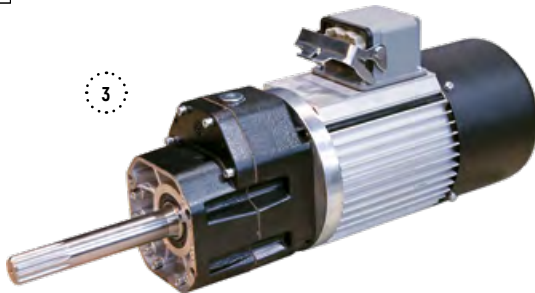
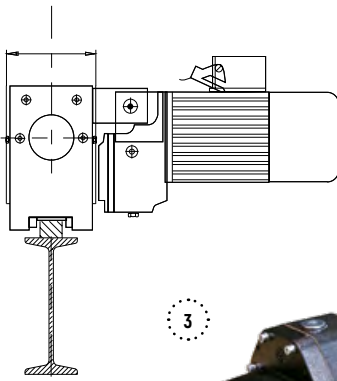

1. HOIST

2. END CARRIAGES

3. GEARED MOTOR FOR TRAVEL

4. ELECTRICAL CABINET

5. FESTOON FOR CRANE



CHARACTERISTICS OF THE STATE-OF-THE- -ART HOIST

1

Design: robust, compact and clean with a modern and technological profile.

No counterweights: lighter and with the most economical structure.

Modular design: changing just a few of the parts allows the hoist configuration to be transformed.

Bolted structure: The maintenance is simpler and avoids the deformation of the welded frame, achieving greater versatility.

Exterior fairing GHA12, GHB11 and GHD13, with a common plate for the entire range of each generation.

Compact tubular double girder concept: More competitive solution than the typical trolley with end carriage on the market. Exclusive to GH.

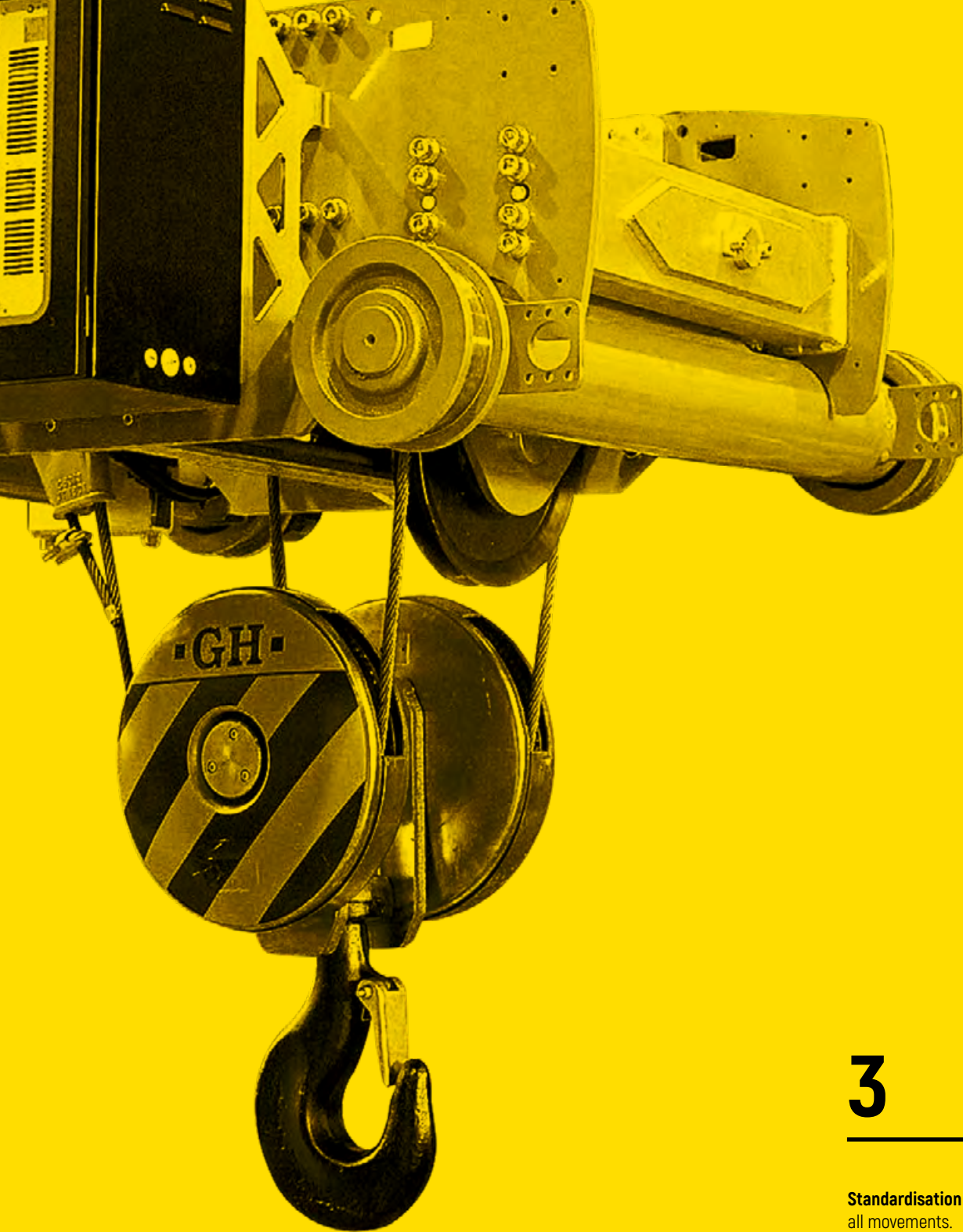

2

Gears made of rectified cemented material. This lengthens the life of the gearbox, manufactured according to ISO 6336. Reduces vibrations and noise of the gearbox.

Protection of travel gear in suspended low headroom: avoids handling and possible entrapment. Prevents the dripping of grease.

Four-gauge pin type load cell: for load limiter, which makes it possible to know the load spectrum and determine the SWP.

Steel wire rope, with coated steel core and safety factor greater than 5 in all configurations.

Quick connectors which facilitate maintenance and save assembly time.

Cabinets with COREBOX, datalogger and connectivity.

Top of the range commercial electrical components: Schneider, Weidmüller, etc.

3

Standardisation of variable speed drive for all movements.

Increased safety: by placing the encoder in lifting that favours the return of the command information from the drive to the motor. Robust and high-resolution design encoder.

High-capacity braking resistance, overload capacity, oversized. High dielectric strength.

Overspeed for small loads: Allows the hoist to go faster if the load is below 25%. With the maximum load it can go at nominal speed. From 25% to 60% maximum overspeed.

Possibility of fitting regenerative drive and the elimination of braking resistors. Energy savings.



LATEST DEVELOPMENTS

STANDARD **GH** HOIST WITH **REGENERATIVE DRIVE**



ENERGY SAVINGS



ENVIRONMENTAL SUSTAINABILITY



CUSTOMER COST SAVINGS

GH B11



The **GH hoists and cranes** have drive control by means of frequency inverters as standard.

The incorporation of regenerative modules enables us to provide great advantages for our customers in large machines.



Committed to technologies derived from industry **4.0** applied to the crane and its interaction with people.



Standard solution for the **remote monitoring** of lifting equipment.



Connectivity via **3G/4G, Wi-Fi and USB.**



User access **via the cloud** to monitor the status of the crane.



Plug & play solution to add **automation functionality** to the cranes.



Synchronism in lifting and crosstravelling **Reduces load sway** without additional sensors.



Connectivity via **3G/4G or USB.**



Allows monitoring of the status of **alarms and consumption.**

+ CORE + STABILITY

Keeps the load stable at higher speeds. It therefore provides greater precision, which results in increased productivity and safety.

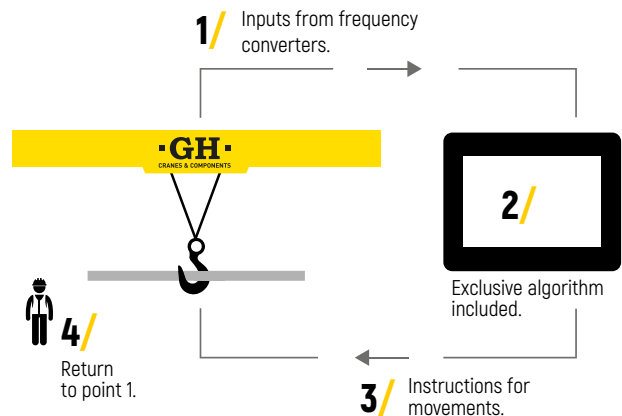

+ INCOTANDEM

For cranes with one or two trolleys that must be synchronised and that work in tandem mode through radio transmission systems.

The advantages are **1** saving in equipment, **2** greater ease of installation and **3** reduced number of frequencies occupied.

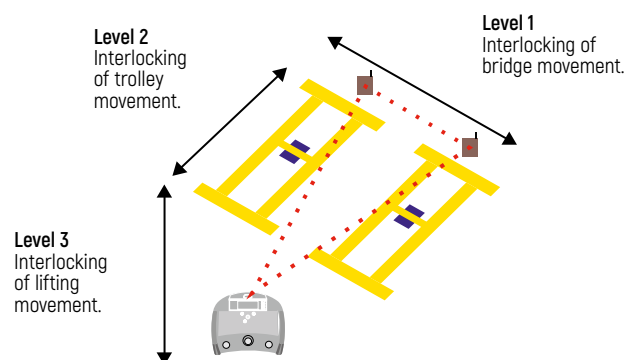

LATEST DEVELOPMENTS



+ TWIN HOIST

Our new solution is based on the work of **two synchronised hoists** that, in addition to lifting the load with the standard design, incorporate a series of advantages such as safety, competitiveness and profitability.

It includes standard commercial components, high wire rope safety to prevent load slipping and speed increased by up to 50% in loads less than $\frac{1}{4}$ of the rated load.

SYNCHRONISED LIFTING OF 200 T WITH **CORE+**

SECONDARY CENTRIFUGAL LIFTING BRAKE

Autonomous operation system by means of a mechanical device that takes advantage of the centrifugal force generated when the load is falling.

The centrifugal brake is mechanically coupled to the drum of the hoist by means of a crown and pinion system.

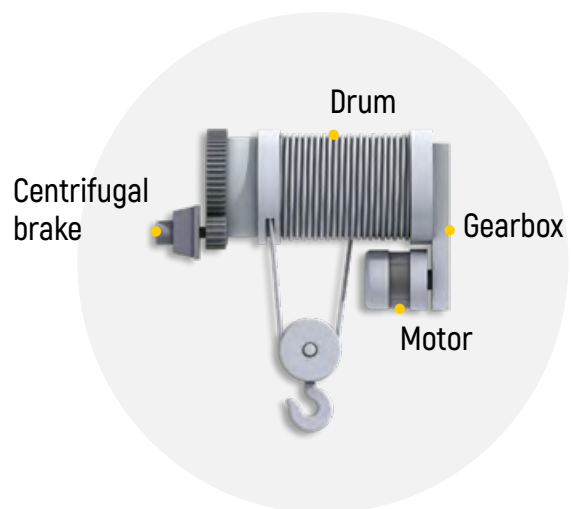

THIS SYSTEM PROVIDES GREATER SAFETY AND MINIMAL MAINTENANCE



BRIDGE CRANES

**ROBUST
AND HIGH
LEVEL OF
STANDARDISATION**

These have a robust construction and a high level of standardisation. Very modular and adaptable to any need, with very reliable components and available for a wide range of applications.

The structure is a box beam or commercial section, optimised by computer-aided calculation processes. Our designs offer the best technical-mechanical option with the best value for money.

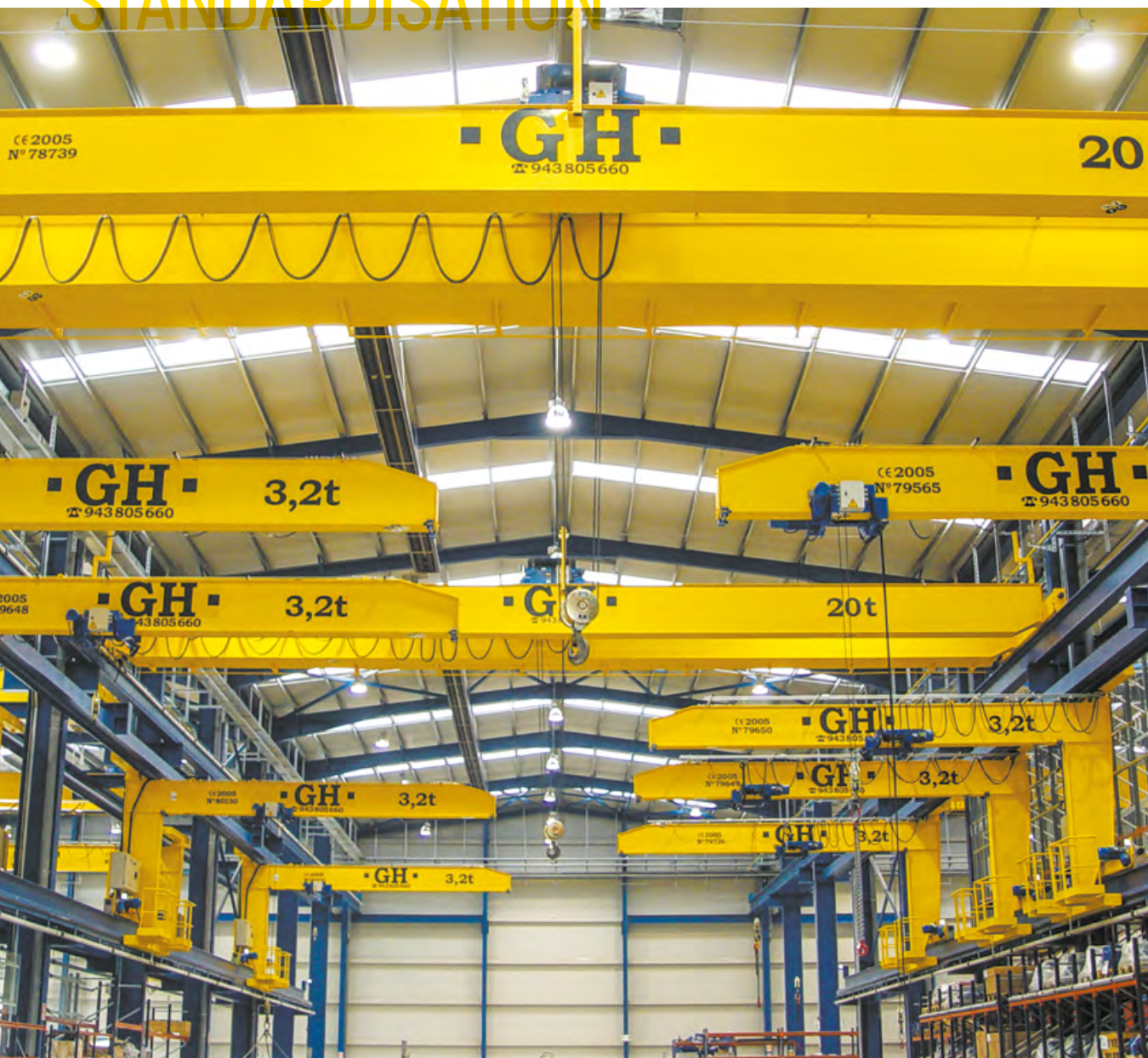

Top running Single Girders crane



The optimised combination of the crane structures with the mechanical equipment for lifting, cross travelling and long travelling, allow the best hook approaches for optimising space and the best use of spaces.

The construction of the structural welded components, with automated and robotic systems, always guarantees the correct repetition of the welding processes and a high quality product.

The mechanisms used in our industrial bridge cranes are an indivisible part of the cranes, taking in the entire range from chain hoists of 500 kg to wire rope hoists of 200 t and open winches up to 400 t.

Double girder crane and cantilever crane



Suspended crane



GANTRIES AND SEMI-GANTRIES

—
Up to 400 t.



GH is a European leader in the design and manufacture of gantry cranes with a large number and variety of applications. Due to the number of gantry cranes installed, **GH** is a leader for this type of machinery.

GH adapts the manufacture of its gantry cranes to the needs and circumstances of each customer, always taking into account the type of work to be carried out and load to be handled.

The experience acquired since 1958 backs us up as specialists in gantry and semi-gantry cranes.



PROCESS CRANES OPEN WINCH



We design special solutions for non-standard lifting mechanisms based on applications or work environments.

MAIN CHARACTERISTICS ARE:

Higher lifting capacities and/or higher lifting speeds and/or higher FEM groups.

The use of commercial motors allows adaptation to customers' standards. 1 motor, instead of applications with a hoist that need 2 motors for the same lifting capacity and therefore double the probability of equipment failure. Possibility of working with motors of 1,500 and 1,000 rpm. Greater sizing of the motor.

Motor-gearbox and gearbox-drum connections use intermediate flexible couplings.

True vertical lift without side displacement of the hook during the lifting operation.

Greater accessibility for maintenance of the different components.

The brake is completely external, improving its accessibility and adjustment.

The gearbox has a top opening lid facilitating access, maintenance and inspection.

Anti-overlapping and slack wire rope detector. The anti-overlapping system is formed by a support and a mechanism with springs fastened with screws, to prevent the cable from leaving the slots of the drum.

MOTORISED TROLLEYS

From 10 t up to 200 t.



The **GH** transfer carts allow the movement of loads at ground level in all types of industries and applications.

They are robust, have a modular construction and are available in a wide range of products and adaptable to any need.

They are equipped with all the necessary safety features for the movement of machines at ground level.

They are an important complement to the cranes for the movement of heavy loads at ground level, being an ideal solution for the transfer of loads between adjacent buildings.

THERE ARE TWO MAIN TYPES OF TRANSFER CARTS, WITH DIFFERENCES IN THE TYPE OF MOVEMENT:

Steerable transfer carts:

These can move freely.
Available in battery-powered version.

Transfer carts on rails:

These move only in a straight line.
Available in battery or power supply versions, by means of a cable reel or power supply line.

**IDEAL SOLUTION FOR THE
TRANSFER OF LOADS BETWEEN
ADJACENT BUILDINGS**

AUTOMOTIVE GANTRIES

—
Up to 600 t.

motion.ghcranes.com



The **GH** automotive gantry cranes on rubber tyres allow the autonomous movement of loads in all types of industries and applications.

At **GH** we have a wide variety of automotive gantry cranes, handling loads ranging from 20 to 600 t, offering efficiency in outdoor yard movements for nautical and industrial sectors. All of them are characterised by their great robustness, simplicity of use, easy maintenance and manoeuvrability, and they are particularly useful for sectors involving prefabricated components and external logistics warehouses (wind power, precast concrete, heavy sheet metal working, container cranes, etc.).

JIB CRANES

From 500 kg up to 20 t.



An ideal solution for the movement of loads in a circular area near the manufacturing station.

With chain and wire rope hoist options, in low headroom or suspended type.

Great precision of movement with manual or motorised versions.

The industrial jib cranes, from 500 kg up to 20 t, allow cantilevers suitable for each type of application.



WALL JIB CRANE

For the handling of lightweight parts during production processes.



COLUMN JIB CRANE

For the handling of light and medium weight parts during production processes where independent manufacturing stations are required with respect to the main cranes in a factory building.



INDUSTRIAL JIB CRANE

For the handling of heavy loads during production processes and industrial activities where independent manufacturing stations are required with respect to the main cranes in a factory building.



PORT JIB CRANE

Also known as Marine Jib Cranes, they are specially designed for lifting heavy loads in port environments.



Port jib crane
Industrial jib crane



DRY DOCKS

Up to 4 t.

OPTIMISING SPACE USAGE AT A BOATYARD

We design and manufacture rail-mounted gantry cranes for dry docks that are adapted to each customer's specific space and needs, optimising use of the space and expanding docking capacity to get the most out of the boatyard.



AUTOMATED SERVICE

Industry developments allow us to design cutting-edge solutions, offering automated dry dock services to facilitate boat docking, storage and delivery to expand a boatyard's service to reach its full potential.

STREAMLINED DELIVERY OF BOATS

Our dry docks are designed to provide customers with the best service, so that they can have their boats ready in just a few minutes through automatic or semi-automatic operations.

PRESERVATION OF BOATS ON DRY DOCK

Boats are not in contact with the water, improving preservation and safety.

WE ADAPT TO EACH MARKET
AND CUSTOMER, WITHOUT ANY REDUCTION
IN QUALITY OR PERFORMANCE.
GH GLOBAL SERVICE.

A 10 OUT OF 10 SERVICE

Wherever our customer is, they can be sure
of a quick and effective response.
We provide a Technical Support Service in the 5 continents.
With advanced technology and continuous advice.

- 1** Comprehensive preventive maintenance.
 - 2** Corrective maintenance.
 - 3** Supply of spare parts.
 - 4** Supply of lifting accessories.
 - 5** Modernisations and renovations.
 - 6** Training of crane operators.
 - 7** Assembly and commissioning of cranes.
 - 8** Standard crane warranty service.
 - 9** Service technology.
 - 10** Connectivity / machine / technician / customer.
-





WE INVEST IN OUR OWN
CAPABILITIES IN ORDER
TO BE ABLE TO PROVIDE
OUR CUSTOMERS WITH A
COMPREHENSIVE SOLUTION

REFURBISHMENT AND UPGRADES



EXTENDING THE LIFETIME OF THE MACHINE

IMPROVING PERFORMANCE AND SAFETY

Modernisation services extend the useful lifetime of an equipment, adapting it to the new needs and improving its safety.

Thanks to our experience and technological know-how, we can handle all kinds of crane modernisation projects, both for **GH** branded cranes and others.

CLOSE AT HAND FOR EVERY CUSTOMER

TRAINING OF OPERATORS

The correct use of our machines requires well-trained operators so that they follow the required standards of maximum safety and efficiency.

We have an operator training protocol that is carefully structured and documented, taught by our training experts.



SPARE PARTS



PARTS & ACCESSORIES is our main warehouse in Madrid-Spain, which supplies the highest quality spare parts to regional service centres around the world, in a very short period of time.

Purchasing the spare part from the Official **GH** Service Network assures you that it is original and comes with the manufacturer's warranty.

SPARE PARTS



ACCESSORIES FOR LIFTING

Hoists, magnets, rockers, claws, clamps, weighing, slings and chains, lifelines, lightweight systems, power supplies, radio controls, lightweight jib cranes and chain hoists.



CONNECTIVITY

This is the technology that connects directly to service technicians, customers, machines and the GH data centre, through the cloud. It shows our customers all the service and operating data of our machines.

GH, through its data centre, can then perform Big Data analysis to better understand the operating patterns of our machines, developing products and services according to the production needs of our customers.



SECTORS

We create particular solutions for specific sectors. We offer the optimal solution to every need. With the experience accumulated since 1958, our extensive capabilities and our own engineering.

WE DEVELOP CRANES AND COMPONENTS FOR ALL TYPES OF INDUSTRIES AND APPLICATIONS, AND FOR EACH WORK ENVIRONMENT.

At **GH** we know that each customer has specific preferences and need, therefore, we are prepared to develop machines that are fully adapted to each business.

Aeronautics

Automotive

Renewable energies

Public works

Iron and steel

Sheet metal working

Foundry

Steel handling

Waste Treatment

Paper Mills

Container Handling

Precast Concrete

Nautical

Shipyards

Railway

Stone handling

Mining

Others





AERONAUTICS

For handling and assembly work processes of the aeronautical industry involving lightweight but large parts, the cranes that are installed have beams with large spans and the hoists require high precision to facilitate the assembly processes.

Cranes with hoist transfers are also installed to lift the components to any part of the factory, improving the production processes.



AUTOMOTIVE



These are cranes for production processes and storage of coils.

They are machines for handling dies and tilting processes. Equipped with several lifting heights in the same bridge, facilitating and making the tilting manoeuvres safe.

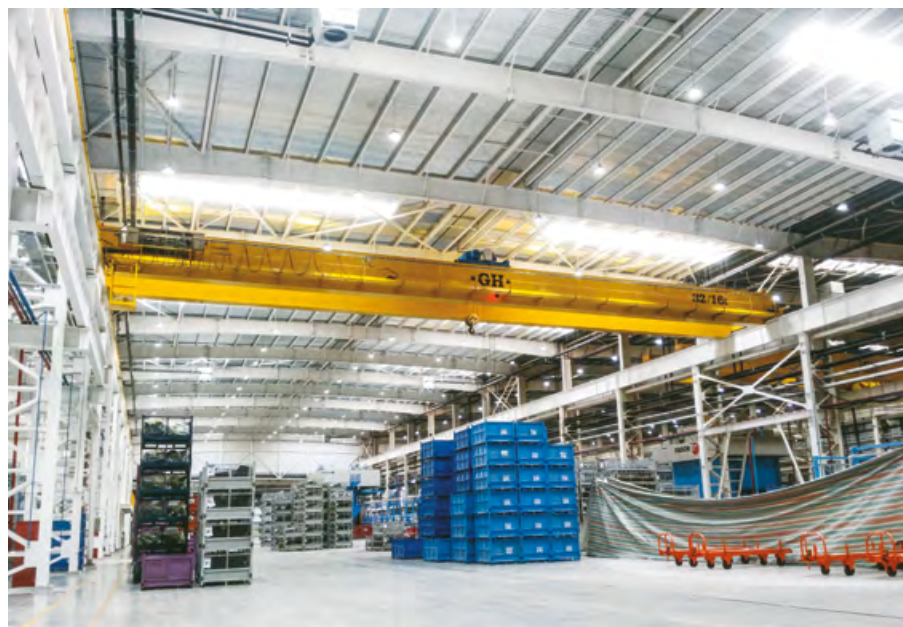

RENEWABLE ENERGIES



In this sector, we have a wide range of products for the handling of the different components that make up the entire wind turbine.

GH has a highly developed and standardised product for Renewable Energy, which has a wide range of lifting capacities and under the hook attachments.



PUBLIC WORKS



We have products designed for different applications in this sector:
Cranes for manufacturing – reinforcement, demoulding, voussoirs,
etc. – gantry cranes for voussoirs, under the hook attachments.

IRON AND STEEL

We have a wide range of products to meet the needs of different processes in the steel industry: casting, rolling, storage, maintenance, etc.

Each of these processes needs a crane suitable for its very specific functions.



SHEET METAL WORKING

We develop robust equipment for tilting with a wide range of lifting capacities suitable for the handling processes, integrating magnetisation equipment or other under the hook attachments for manoeuvring.



CASTING

Process cranes for handling molten iron with exceptional lifting safety and smooth and progressive manoeuvres.

These are cranes adapted to the difficult environmental conditions of the premises in which they have to carry out their work: high temperatures, aggressive suspended dust, etc.

In this sector, we also have cranes for handling moulds.



STEEL HANDLING

These are mainly warehouse cranes. This is equipment of average and low capacity, sufficiently agile to handle different steel warehouse products: sections, rebar, rods, tubes, etc.

WASTE TREATMENT

Production equipment with high speeds and outstanding performance to comply with the work cycles in line with the capacity of the plant, including manual, semi-automatic and automatic.



PAPER MILLS

Both process and maintenance equipment with large tonnage and particularly suitable for environments with high humidity and high temperatures.





PRECAST CONCRETE

We have products designed for different applications in this sector: Cranes for manufacturing – rebar, demoulding, etc.

Standardised cranes with “true vertical lift” to guarantee the proper demoulding of the precast concrete.

As in the Public Works sector, productivity is the priority with speeds according to the demands of customers.

CONTAINER HANDLING

Process cranes for storage with high lifting heights and where sway control becomes a critical aspect for the configuration of our equipment.

NAUTICAL



Products adapted to the marine environments for which they are intended.

Nautical jib cranes and self-propelled gantry cranes with a wide range of capacities to fully cover the very specific requirements of this demanding sector and the differentiated profile of its customers.



SHIPYARDS

For this sector, **GH** offers robust equipments with several lifting heights in the same bridge, both independent and synchronised for tilting, with the possibility of integrating magnetisation and welding equipment into our cranes.

These equipments are suitable for heavy loads and great volumes.



RAILWAY



We differentiate between maintenance and manufacturing cranes.

These equipments need perfect synchronisation between cranes for cases of carriage handling with two or more bridges. We also have special (standardised) equipment for handling stations, transfer of rail tracks, etc.

Maintenance cranes are simple cranes from the standard range adapted to the needs of each process.

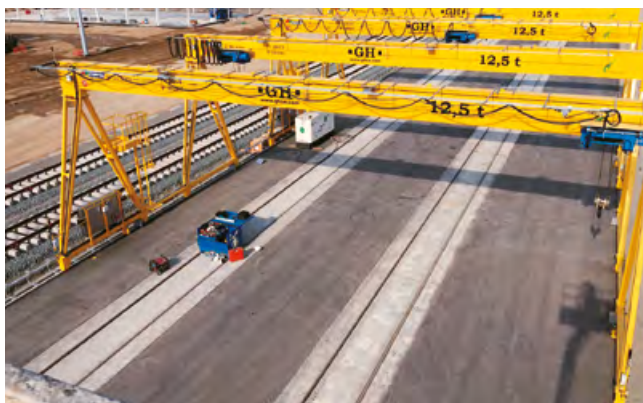

STONE HANDLING

The products we offer are standardised machines of medium and high capacity. These are gantry cranes for outdoor works and raw stone storage.



MINING

A wide range of products in terms of lifting capacities and hook travel, incorporating suitable and oversized mechanisms for works at high altitudes above sea level and in difficult conditions in underground spaces, galleries, etc.







CE 2001
N°66338

H
3 80 56 60

- GH -
943 805 660

APPROACHING**GH**

WE GUARANTEE
A FAST, EFFICIENT
AND PRECISE RESPONSE,
AT ALL TIMES AND
ANYWHERE IN THE WORLD.
HOW?

WE ARE ALWAYS
CLOSE AT HAND.

GLOBAL PRESENCE

THE EFFORT TO EXTEND OUR PRESENCE AND ACTIVITIES HAS MADE US INTO A MULTI-LOCATION COMPANY. **ALL OUR CUSTOMERS ARE GUARANTEED TO HAVE ACCESS TO A PROPER SERVICE THAT PROVIDES A RESPONSE TO THEIR NEEDS**

Our presence in the American continent

with three production plants that extend strategically from North to South, makes us a leading brand.

Our factories in Southern and Central Europe put us in a great position to serve all European customers.

Our production plant in Thailand and our presence in China and India give us a magnificent base from which to serve the Asian market.



Lifting
your **world.**

GH, Europe



Spain Beasain



Spain Olaberria



Spain Alsasua



Spain Bakaiku



Portugal São Mamede do Coronado



France Saint-Herblain



Poland Kłobuck

GH, America



U.S. Illinois



U.S. Texas



Mexico Querétaro



Colombia Bogotá



Peru Lima



Brazil Cabreúva

GH, Asia



UAE Dubai



India New Delhi, Delhi



Thailand Chonburi



China Shanghai

125,000+

Cranes sold

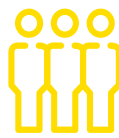

+1.000 employees

Worldwide technical service



THE POWER OF ADDING DIVERSE STRENGTHS

GH's presence in all these markets has given us the ability to combine different knowledge and cultures in order to adapt ourselves in line with the phrase that summarises our position with respect to international markets: "Think global, act local".

Our products, designed at the heart of the company, are the same in all markets, maintaining the same features in terms of safety, quality and capacity.



"THINK GLOBAL,
ACT LOCAL"

GH TESTIMONIES FROM AROUND THE WORLD. THE POWER OF THE CONNECTION BETWEEN CULTURES THAT MAKES US BETTER



DAVID MOULIN
Sales Manager
GH France

“GH is almost an inseparable part of my working life. For me, GH has become a way of understanding the world and relationships between people. For a Spanish company to start working in the French market in the 1990s was a fabulous challenge because, although we are only separated by a nearby border, the different mentalities were an almost insurmountable obstacle. However, the language of a very reliable product, an independent business project and a healthy ambition to extend activities in international markets has allowed us to become very close to our French customers. And in my personal life, I'm almost an inseparable part of the organisation of the company. And I'm proud of it.”



WHITE WU
Head of the project
department of GH China

“When I first came into contact with GH in my professional career, I thought it was a European company with the ambition to find a market in China in a competition based on price and on the principle of “as cheap as possible”. When I got to know GH I found it is a very different kind of company with an excellent product and in search of opportunities with customers who value all value quality, integrity and a commitment to doing things well.”



MÓNICA RUIZ
Assistant Administrative and Financial
Manager GH Mexico

“We already have a history in Mexico that goes back 20 years. GH first set up operations in Mexico in 1999 and after a settling-in period which included difficulties, achievements and lessons learned, we are now a well-established reality, with a team of committed people and with a brand image that puts us in an outstanding position for the next 20 years. For me, GH Cranes is a company of opportunities that also challenges you in all kinds of ways. During my time at GH, they have always given me support and shown trust and above all they have believed in me professionally and as a person, which has made me enjoy my work and has kept me motivated and proud of belonging to this great family.”



TOMASZ CHĘCIŃSKI
Product leader
GH Poland

“GH is a very advanced company in terms of processes and production techniques. For me it is a real pleasure to share my knowledge with the company that has made this commitment to Poland with the installation of one of its factories abroad.”

“GH in Colombia is just beginning, but I've already seen that we are making steady progress in establishing a place for ourselves in the market. I believe that the GH product and the company's organisation and strategies mean that we will soon consolidate our position in this market because of the cultural affinity and the quality of the solutions we offer. Personally, it is exciting to work for a multinational European company that has such deep-rooted values.”



JUAN CARLOS GAMBA
Projects and Maintenance Manager
GH Colombia

“Since GH has established itself in Thailand through the LGH joint venture, I feel that I am part of a winning project that will soon produce great results in this country and in the region as a whole. Now we have a factory that is a model example for the whole sector and market and soon we will have the big excitement of becoming market leaders. For me, GH is an exciting project in which I am developing as a person and as a professional.”



NUTCHARI WANMA
Sales Director
GH Thailand

THE SYNTHESIS: THE CUSTOMER PORTAL

Our efforts are not only aimed at the value that we incorporate into the product. Our whole philosophy revolves around two concepts:

PEOPLE AND THE CUSTOMER

These premises shape our way of acting.



IN THIS PLATFORM WE BRING TOGETHER THE VERY LATEST COMMUNICATION TECHNOLOGY TO PROVIDE COMPREHENSIVE SERVICE MANAGEMENT THAT ALLOWS:

Online reporting of incidents for the crane.

The prevention of future problems that may affect production.

Rapid intervention in the event of uncontrollable incidents.

The availability of statistical information on the activity of the cranes so that the customer can make the appropriate decisions.

Simple, shared and secure administrative management for the customer and the service provider.

Telematic control of the crane's performance and incorrect actions in the handling of the cranes.



On this website, GH-GS shows its customers all the service information and operational data via the cloud.



OPERATIONAL DATA



CORESOURCES

- Document management
- Contract Management
- Issuing of warnings
- Data record

COREINSIGHT

- Indicators about the operating conditions
- Proactive alarms about the operating conditions
- RAM indicators and Reports
- Technical advice

GH-GS APP

All our technicians work with this technology, where they record all the service data: fault codes, spare parts used, checklists, maintenance reports, technical documentation, etc.

+ GH-GS APP

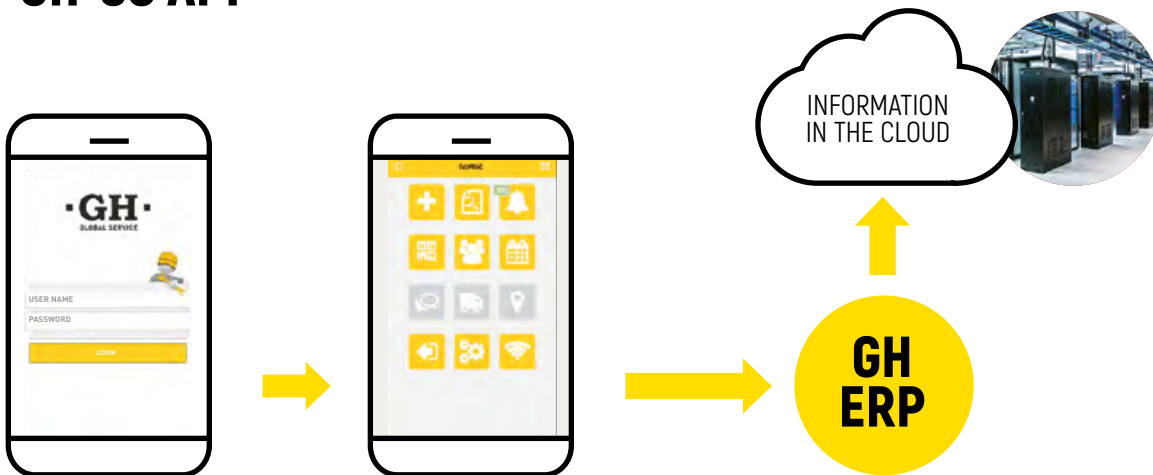

+ COREBOX

This is a datalogger that collects data and operating parameters from different crane devices.

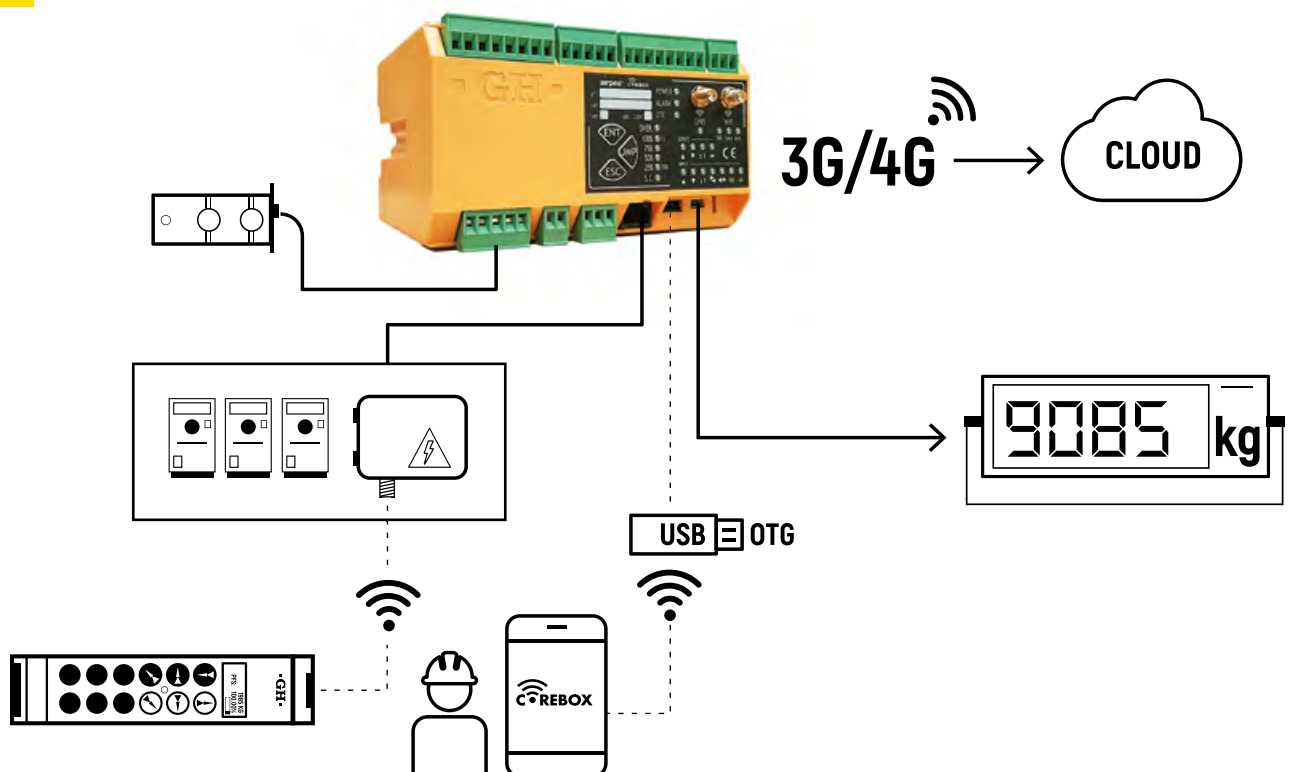



THINKING**H**

WE ARE MOVING
TOWARDS
THE SMART CRANE.

HOW?

WE INNOVATE
IN THE PRODUCT
AND THE SERVICE.

—

OUR TEAM IS COMMITTED TO QUALITY AND INNOVATION

**We are moving steadily
towards the smart crane.**

To achieve this, we work with **technology partners** who enable us to generate knowledge faster. And we collaborate with top-level European technology centres.

We are people from multiple countries who share the same mission.

We offer our own solutions to specific needs. Technology and productive capacity to provide comprehensive solutions to the customer's needs.

This philosophy and the commitment to being one step ahead has made us pioneers in the application of new technologies in standard products. We were the first to include the variable speed drives in all movements.



WE BELIEVE IN THE POWER
OF COOPERATION.
WITH CUSTOMERS AND SUPPLIERS



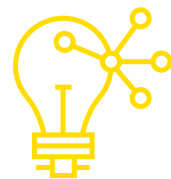

1



Web configurator that allows us to provide a quote for a crane, anywhere in the world, at any time.

GH 4.0

2



Top of the range calculation tools for structures and gears (KISS, ANSYS), 3D and 2D design tools (SolidWorks, AutoCAD).



▪ GH ▪

The world of **industry 4.0** has made a strong entry into the world of cranes. GH has internalised this new scenario and makes constant investments with the aim of achieving greater digitisation, with a firm commitment to automation and a constant search for improvement in the field of the connection between companies and machines.

3

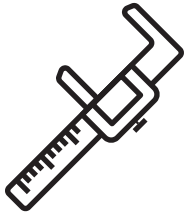

Metrology laboratory:
for the dimensional control
of the parts we machine.



Lasertracker. For the dimensional control
of the cranes we use a maximum precision
laser machine.

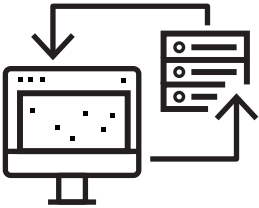

Monitoring in real time of the current status of the
manufacturing process with data collection terminals
in the plant.



4

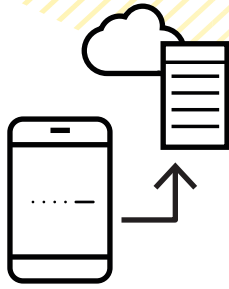

"Mobile Service" APP for the management of preventive, corrective and other maintenance activities for Service technicians, through which they receive notifications, fill in work reports and carry out other tasks, which reduces paper use to zero, and the information is available for GH and the customer instantly through the Customer Portal.

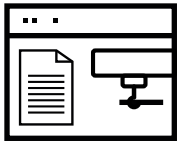

Customer portal: where customers can find the original crane documentation, as well as information associated with the repairs and maintenance of each crane.

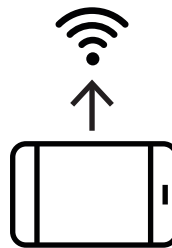

Remote monitoring of the operational data of the crane through the IoT Platform for the collection and processing in real time of the service data of our machines, which increases the possibility of predictive maintenance and enables more rapid corrective maintenance action.



PORTAL.GHCRANES.COM

CORESOURCES

Document management.
(Faults/Reports/Delivery notes/Invoices).
Contract Management.
(Inspection report/Post-maintenance quotes).
Issuing of warnings.
Data record.

COREINSIGHT

Indicators about the operating conditions.
(Overloads/temperatures/Variable speed drive failures, etc.).
Proactive alarms about the operating conditions.
RAM indicators and Reports.
Technical Advice.

COREBOX



3G/4G

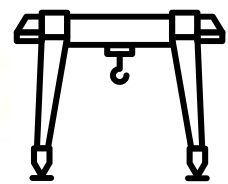

MONITORING





GH

GH
www.ghsa.com

GH

GH
943805660

GH





FELLOW TRAVELLERS

OUR CUSTOMERS
HAVE SHOWN US
THE WAY.
WE HAVE JUST
ACCOMPANIED THEM
ON THEIR JOURNEY.

—



DEVELOPMENT, PRODUCTION, PROJECT MANAGEMENT AND THE SERVICING OF WIND TURBINES IN THE ONSHORE SEGMENT HAVE BEEN THE MAIN COMPETENCE AND PASSION OF THE NORDEX GROUP AND ITS 5,500 EMPLOYEES AROUND THE WORLD FOR MORE THAN 30 YEARS. AS ONE OF THE WORLD'S BIGGEST MANUFACTURERS OF WIND TURBINES, UNDER THE BRANDS ACCIONA WINDPOWER AND NORDEX, THE NORDEX GROUP OFFERS LOW-COST, HIGH-PERFORMANCE WIND TURBINES WHICH ENABLE THE LONG-TERM AND ECONOMIC GENERATION OF WIND POWER IN ANY GEOGRAPHICAL REGION AND CLIMATIC CONDITIONS.



CAF IS ONE OF THE WORLD'S LEADING COMPANIES IN THE RAIL SECTOR. WITH A GREAT CAPACITY TO RESPOND TO THE DEMANDS OF THE MAJOR WORLD MARKETS, ITS TRAINS GIVE IT A PRESENCE IN THE MAIN RAIL INFRASTRUCTURE PROJECTS AROUND THE WORLD. ITS INNOVATION POLICY IS A MODEL FOR THE BUSINESS COMMUNITY.

OUR CRANES HAVE ALSO ACCOMPANIED THIS CENTURY-OLD COMPANY IN ITS SUCCESS.



THE BRAZILIAN AERONAUTICAL MANUFACTURER IS ONE OF THE MAIN BENCHMARKS IN THE PASSENGER TRANSPORT SECTOR.

ITS DEMANDING POLICIES FOR SUPPLIERS IN TERMS OF SAFETY, EFFICIENCY AND MAXIMUM PERFORMANCE HAVE MADE GH PROUD TO BE AMONG THE PARTNERS THAT HAVE ALLOWED EMBRAER TO BECOME ONE OF THE LEADING COMPANIES IN THE WORLD OF AERONAUTICAL CONSTRUCTION.



IRIZAR IS THE PARENT COMPANY OF A BUSINESS GROUP THAT IS CURRENTLY ACTIVE IN SIX SECTORS: PASSENGER TRANSPORT, ELECTROMOBILITY, ELECTRONICS, ELECTRIC MOTORS AND GENERATORS, CONNECTIVITY AND ENERGY.

MADE UP OF MORE THAN 3,350 PEOPLE, THE IRIZAR GROUP CARRIES OUT ITS ACTIVITY IN FIVE PRODUCTION PLANTS FOR COACHES AND BUSES (SPAIN, MOROCCO, BRAZIL, MEXICO AND SOUTH AFRICA) AND IN ANOTHER SIX COMPANIES IN DIFFERENT SECTORS OF ACTIVITY IN SPAIN AS A RESULT OF ITS INDUSTRIAL DIVERSIFICATION POLICY. IN ADDITION, IT HAS ITS OWN R&D CENTRE WHICH ALLOWS A LONG-TERM APPROACH TO THE PROCESS OF APPLIED RESEARCH AND TECHNOLOGICAL DEVELOPMENT OF THE GROUP'S OWN PRODUCTS AND SYSTEMS.

IRIZAR IS A BENCHMARK IN ITS SECTOR AND IN THE APPLICATION OF ENERGY EFFICIENCY TECHNOLOGIES, RESPECT FOR THE ENVIRONMENT AND SUSTAINABILITY, WITH RECOGNITION FROM THE MARKET AS A WHOLE.



THE AMERICAN GIANT IN THE CONSTRUCTION OF MACHINERY IS A MAJOR COMPANY THAT HAS BEEN AT THE HEART OF THE DEVELOPMENT OF INFRASTRUCTURES THAT HAVE ALLOWED HUMANITY TO EVOLVE.

CATERPILLAR HAS CHOSEN GH AS A SUPPLIER OF CRANES IN ITS PRODUCTION CENTRES, ESPECIALLY IN MEXICO BUT ALSO IN OTHER COUNTRIES. THIS MAKES US PROUD AND PLACES US IN THE GREAT SITUATION OF CONTINUING TO "RESPOND TO THE CHALLENGE".



WHEN A **GH** CRANE LEAVES THE FACTORY, WE KNOW THAT IT WILL REACH GREAT HEIGHTS. THE SAME HEIGHTS AS OUR CUSTOMERS



- ACCIONA
- ACERINOX
- ACEROMEX
- ACEROS AREQUIPA
- AÇOTEL
- AERIS ENERGY
- AIRBUS
- AKE
- INFRASTRUCTURE
- ALSTOM
- AQUALIA
- ARCELORMITTAL
- AVIANCA
- BREMBO
- BUDIMEX
- CAF
- CATERPILLAR
- CEMENGAL
- CIE AUTOMOTIVE
- COBERMETAL
- CODEME
- COMANSA
- COPACHISA
- COSENTINO
- DANFOSS
- DANOBAT
- DIAMOND C
- TRAILERS
- DOOSAN
- ELECNR
- EMBRAER
- FAURECIA
- FIAT
- FINANZAUTO
- FCC
- FERROVIAL
- FUNDIFAS
- GAMESA
- GENERAL ELECTRIC
- GESTAMP
- GPI TANKS
- GUARDIAN GLASS
- HARBIN HAFEI
- AIRBUS COMPOSITE
- HEIMBACH
- HONGDU
- AVIATION
- HYUNDAI
- INDAR
- INTEGRITY
- TOOL & MOLD
- JIULI
- KOMATSU
- KONSORCJUM
- STALI
- LIEBHERR
- LLAXTA
- MAHINDRA
- METALS USA
- MOLDTECH
- MTU
- NAVANTIA
- NATIONAL OILWELL VARCO
- NISSAN
- NOVARES
- NORDEX
- PICHON
- POWER ELECTRONICS
- RENFE
- RELIABLE REBAR
- RSTEEL FÁBRICA DE TUBOS METÁLICOS
- SAICA
- SAKANA
- SAMASZ
- SEAT
- SERMEFIT
- SHIMIZU
- SHOUGANG
- SIAM CEMENT GROUP
- SIEMENS
- SOFIDEL
- STADLER RAIL
- STALPROFIL
- STECON
- TALGO
- TECNOARANDA
- VALE
- VOLVO
- WUTKOWSKI



COMMITMENT TO OUR CUSTOMERS



OLEA PRIZE AND STARTUP CONTEST

SUPPORTING YOUNG TALENT

—

OLEA PRIZE

OLEA is the name of the farmhouse in which the Guerra family, founders of GH, lived and developed their entrepreneurial aspirations. That's why it was the obvious name for this programme.

OLEA is GH's legacy to keep alive that entrepreneurial spirit that motivated us more than six decades ago and that still drives us forward into the future, a legacy which aims to return the trust and support we have received over more than 60 years in the business. Because after so many years of experience we have learned that in order to reach the top it is essential to have a good company to advise and encourage you.

In 2019, GH launched the **GH OLEA Innovation Prize** project. This initiative consists of two support programmes aimed at two specific groups. And in both cases it seeks innovation for the crane sector in the areas of **safety systems, automation, and digitisation and data analysis.**

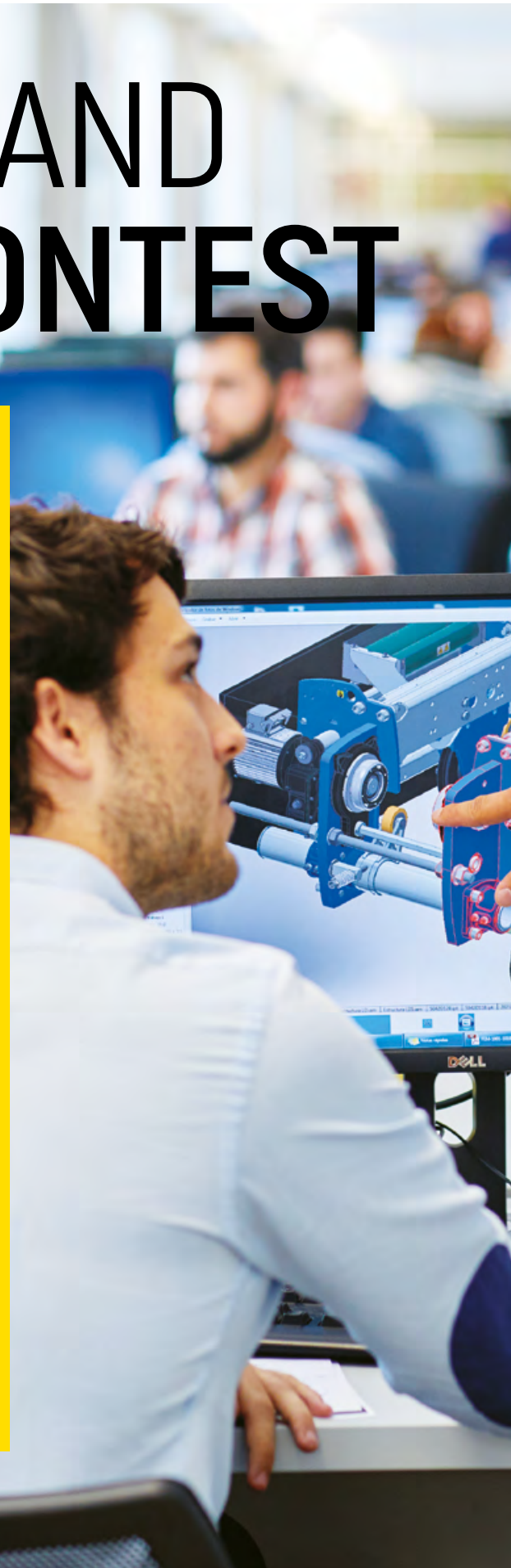



GH CRANES PRIZE FOR INNOVATION

1 / GH CRANES PRIZE FOR STUDENTS.

For undergraduates in the last year of their degree course or PhD students with innovative proposals with potential for commercial application in the crane sector. GH undertakes to provide financial support and advice to the two winning projects.

2 / GH START-UP CONTEST PROGRAMME FOR BUSINESS PROJECTS.

We are looking for business projects and start-ups related to our field of activity in order to collaborate with them.

GH CRANES will support the selected project in different ways:

- Through preferential contracts for the purchase of the products developed by the new project.
- With the possibility of participating as an industrial and/or investment partner.
- Helping to find new investors or partners of another type.

You can find more information and register in olea.ghcranes.com

**SPAIN
GH CRANES & COMPONENTS
CENTRAL OFFICE**

Apdo. 27 - B Salbatore
20200 Beasain (Gipuzkoa) Spain
T +34 943 805 660
F +34 943 888 721
E-mail: ghcranes@ghcranes.com
www.ghcranes.com

GH GLOBAL SERVICE
Polígono Basozabal, 2
20212 Olaberria (Gipuzkoa) Spain
T +34 902 205 100
globalservice@ghcranes.com

**MECANIZADOS ALSASUA, S.L.
MACHINING CENTRE**
Polígono Ibarria, 37
31800 Altsasu (Navarra) Spain
T +34 948 467 625

**GH GUERRA MANUTENCIÓN
GUEMA, S.A.
CRANE MANUFACTURE**
Aiztiko Ind., 3
31810 Bakaiku (Navarra) Spain
T +34 948 562 611

**BRAZIL
GH DO BRASIL
IND. E COM. LTDA.**

Acesso pela Rod. Dom Gabriel
P.B. Couto, Km 81
13313-000 Cabreuva, Brazil
T +55 1144090066
vendas@ghcranes.com.br

**COLOMBIA
GH COLOMBIA SAS**
Carrera 48 No 91-93 Castellana
Bogotá, Colombia
T +57 (1) 7504427
ventasghcolombia@ghcranes.com

**FRANCE
GH FRANCE, SA**
ZI Le Pan Loup
Rue du Moulin de la Rousselière
44800 Saint-Herblain, France
T +33(0) 240 861 212
ghfrance@ghcranes.com

**INDIA
GH CRANES INDIA PVT. LTD.**
A-3, Saket District Centre,
District Centre, Sector 6,
Pushp Vihar, New Delhi, Delhi,
110017, India
T +91 7030 70 5000
ghindia@ghcranes.com

**MEXICO
GRÚAS GH MEXICO SA DE CV**
Retorno 1, nº 28.
Fraccionamiento Agroindustrial
La Cruz
El Marqués 76240 Queretaro,
México
T +52 44 22 77 55 03
+52 44 22 77 50 74
ghmexico@ghsa.com.mx

**PERU
GH PERÚ S.A.C**
Calle Bolognesi, 125 Of. 19,
Miraflores
15074 Lima, Perú
T +51 1 734 32 99
+51 987816231
ventasghperu@ghcranes.com

**POLAND
GH CRANES SP. Z O.O**
Ul. Górnicza 2b
42-100 Kłobuck, Poland
T +48 34 359 73 17
office@ghsa.pl

**PORTUGAL
GH PORTUGAL**
Zona industrial do Soeiro, Lote 9
4745-399 São Mamede do
Coronado - Trofa, Portugal
T +351 229 821 688
ventasghperu@ghcranes.com

**SHANGHAI
GH (SHANGHAI) LIFTING
EQUIPMENT CO., LTD.**
Floor 7, No. 966, Huaxu
Road 201702 Qingpu District
(Shanghai)
T +86 21 5988 7676
ghcranes@ghcranes.com.cn

**THAILAND
LGH CRANES CO., LTD**
137/4 Moo 8, Nongsak-Noenmok
Road, Nong I-run, Ban Bueng
20220 Chonburi, Thailand
T +66 (0)-2327 9399
F +66 (0)-2327-9371
ghthailand@ghcranes.com

**UNITED ARAB EMIRATES
GH CRANES ARABIA FZCO**
Office no. 517, 5th Floor, Jafza
Building 16, Jebel Ali Free Zone.
P.O Box Number - 263594, U.A.E.
T +971 4 8810773
gharabia@ghcranes.com

**USA
GH CRANES & COMPONENTS
SPARE PARTS Y COMPONENTS**
9134 Gulfstream Road
60423 Frankfort (Illinois), U.S.A.
T (815) 277-5328
ghcranesusa@ghcranes.com

MANUFACTURE AND SERVICE
14891 Hwy 205
75160 Terrell (Texas), U.S.A.
T (972) 563-8333
ghcranesusa@ghcranes.com

